

## Schottky Barrier Rectifiers

### Features

- Low power loss, high efficiency
- High current capability
- High surge capability
- Fast switching speed

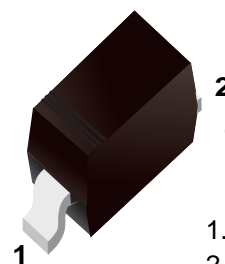

1.Cathode  
2.Anode

### Simplified outline(SOD-323)

Top View 

### Maximum Ratings and Electrical characteristics

Ratings at 25 °C ambient temperature unless otherwise specified.

Parameter	Symbols	BAS70WS	Units
Maximum Repetitive Peak Reverse Voltage	$V_{RRM}$	70	V
Maximum Average Forward Current at $T_a=25^{\circ}\text{C}$	$I_O$	0.2	A
Power Dissipation	$P_{TOT}$	225	mW
Peak Forward Surge Current, 8.3ms single half sine-wave superimposed on rated load (JEDEC method)	$I_{FSM}$	25	A
Maximum Instantaneous Forward Voltage	$V_F$	0.47 @ $I_F=1.0\text{mA}$ 0.75 @ $I_F=10\text{mA}$ 1.0 @ $I_F=15\text{mA}$	V
Reverse Breakdown Voltage @ $I_B=10\mu\text{A}$	$V_{(BR)}$	70 (min)	V
Maximum DC Reverse Current at Rated DC Blocking Voltage	$I_R$	0.1 @ $V_R=50\text{V}$ 1.0 @ $V_R=70\text{V}$	$\mu\text{A}$
Typical Junction Capacitance at $V_R=0\text{V}$ , $f=1\text{MHz}$	$C_j$	30	pF
Storage and Operating Junction Temperature Range	$T_j, T_{stg}$	-55 ~ +150	$^{\circ}\text{C}$

**Fig.1 Forward Current Derating Curve**

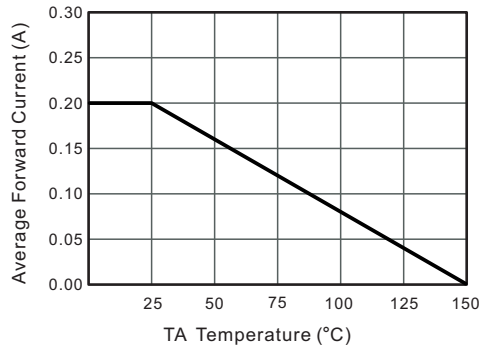

**Fig.2 Typical Reverse Characteristics**

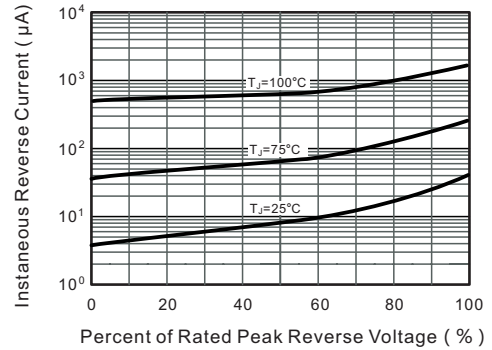

**Fig.4 Typical Forward Characteristics**

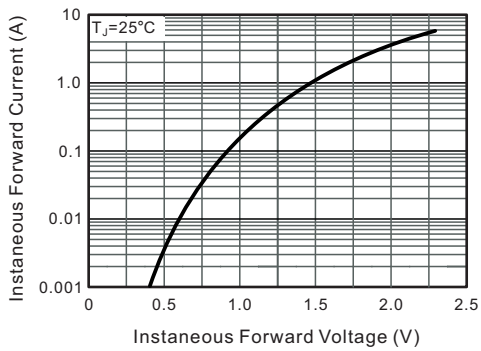

**Fig.4 Typical Junction Capacitance**

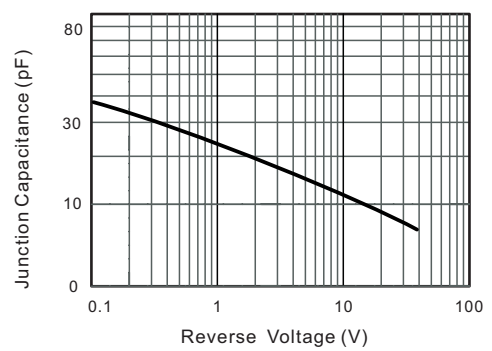

**Fig.5 Maximum Non-Repetitive Peak Forward Surge Current**

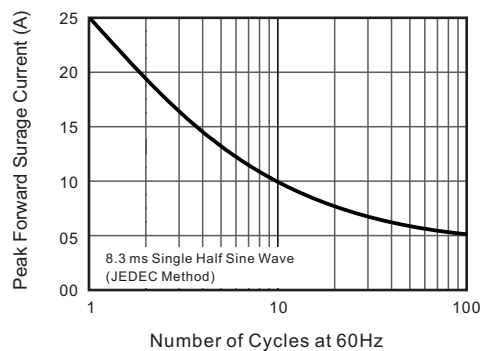

**Fig.6 Typical Transient Thermal Impedance**

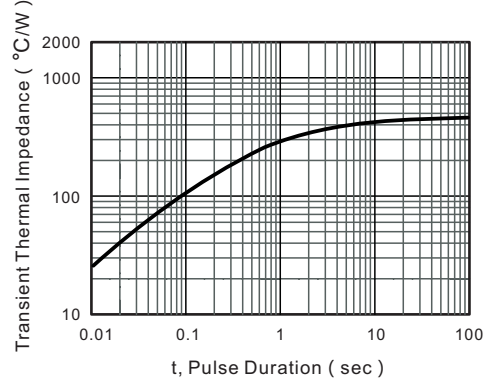

## ■ SOD-323

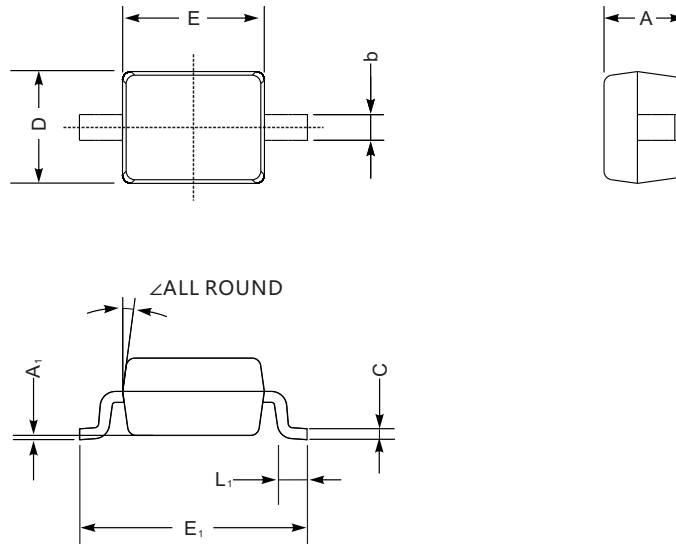

SOD-323 mechanical data

UNIT		A	C	D	E	E <sub>1</sub>	b	L <sub>1</sub>	A <sub>1</sub>	∠
mm	max	1.1	0.15	1.4	1.8	2.75	0.4	0.45	0.2	9°
	min	0.8	0.08	1.2	1.4	2.55	0.25	0.2	—	
mil	max	43	5.9	55	70	108	16	16	8	
	min	32	3.1	47	63	100	9.8	7.9	—	

## ■ The recommended mounting pad size

